

Urinoirs AUBAGNE 2 et NOGENT 2



CE **Aubagne 2**
NF **003639 00 000 100** Urinoir céramique à effet d'eau, petit modèle.

CE **Nogent 2**
NF **003629 00 000 100** Urinoir céramique à effet d'eau, grand modèle.

- Fixation : par crochets de lavabo fournis.
- Avec bonde 1 1/4" à grille inox.
- Blanc 000 uniquement.

Existent également en version pack prêt à installer :

083639 00 000 300 pack Aubagne 2.

083629 00 000 200 pack Nogent 2.

- Avec robinet 1/2" temporisé à alimentation apparente.
- Avec tubulure d'alimentation à effet d'eau.

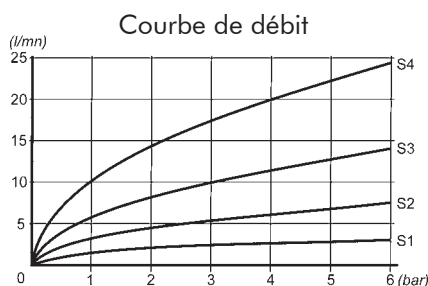

Accessoires :

000260 crochet spécial pour montage en angle (prévoir 2 pièces par urinoir).

007980 séparation d'urinoirs céramique 40 x 75 cm, avec fixations murales et caches.

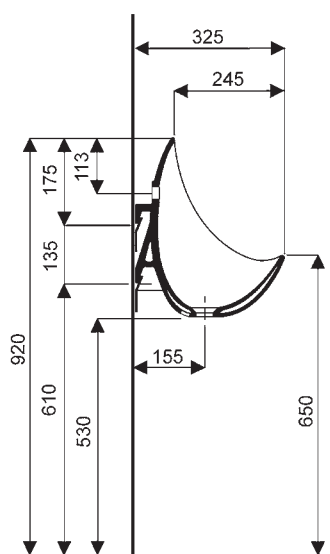
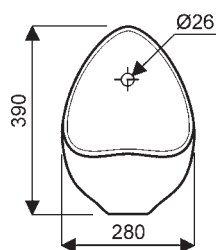

urinoir AUBAGNE 2

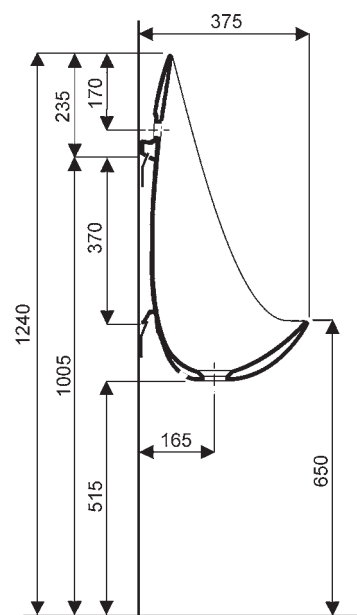
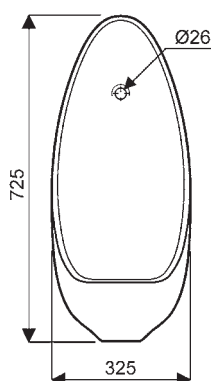





urinoir NOGENT 2

Robinetteries et effets d'eau compatibles :
voir au verso.



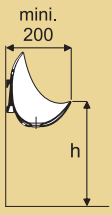

Urinoirs AUBAGNE 2 et NOGENT 2

Recommandations :

Urinoir :			
	2 à 3	4 à 6	7 à 11 ans
	h = 400 mm		h = 400 à 500 mm
			 003639 00
<i>Dimensions moyennes en mm</i>			

Les informations spécifiques données ci-dessus sont issues de circulaires ou CCTP émanant du Ministère de l'Education Nationale.

Montage de face - effets d'eau compatibles

alimentation	AUBAGNE 2		NOGENT 2	
	 apparente	 encastrée	 apparente	 encastrée
DELABIE :				
robinet	777000	778000	777000	778000
tubulure	751000	751000	750000	750000
BINE :				
robinet	303515	403515	303515	403515
GROHEDAL :				
robinet	37033	37030	37033	37030
tubulure	95930	95930	95930	95930
PRESTO :				
robinet + tubulure	31993	31990	31973	31970

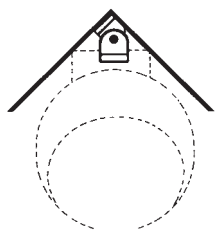

Montage en angle - effets d'eau compatibles

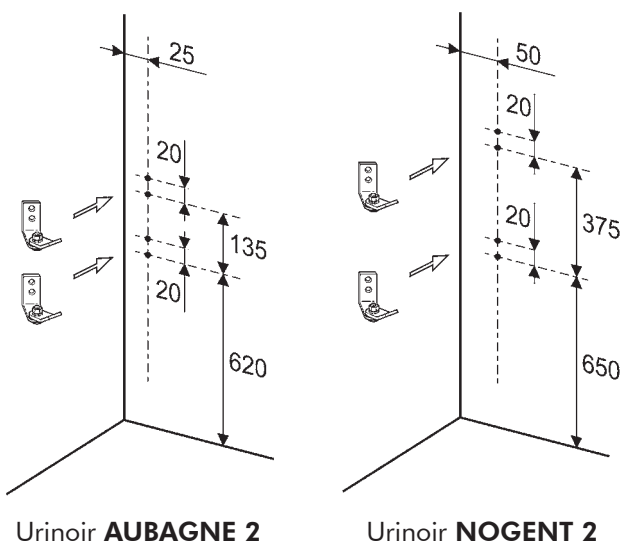

alimentation	AUBAGNE 2	NOGENT 2
	 apparente	
DELABIE :		
robinet	777000	777000
tubulure	751000	751000
cale d'angle	770045	770045
PRESTO :		
robinet + tubulure + cale d'angle	31996	31996

Mkt. Tech 01/2012